

## Surgical Technique



Acumed® is a global leader of innovative orthopaedic and medical solutions.



We are dedicated to developing products, service methods, and approaches that improve patient care.

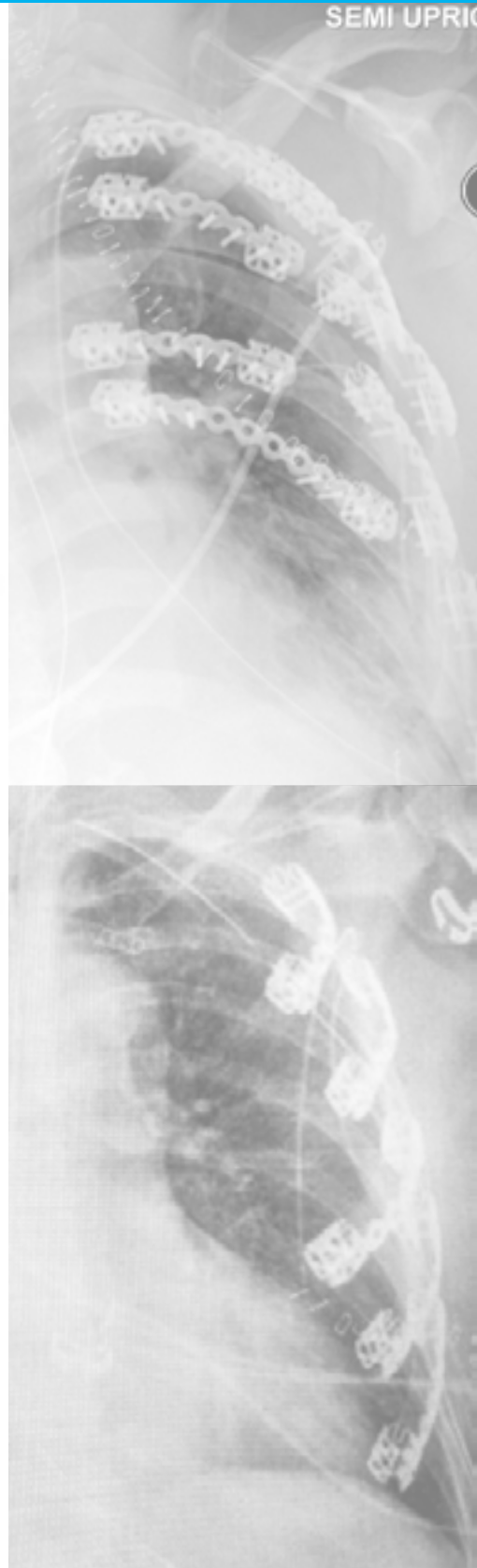
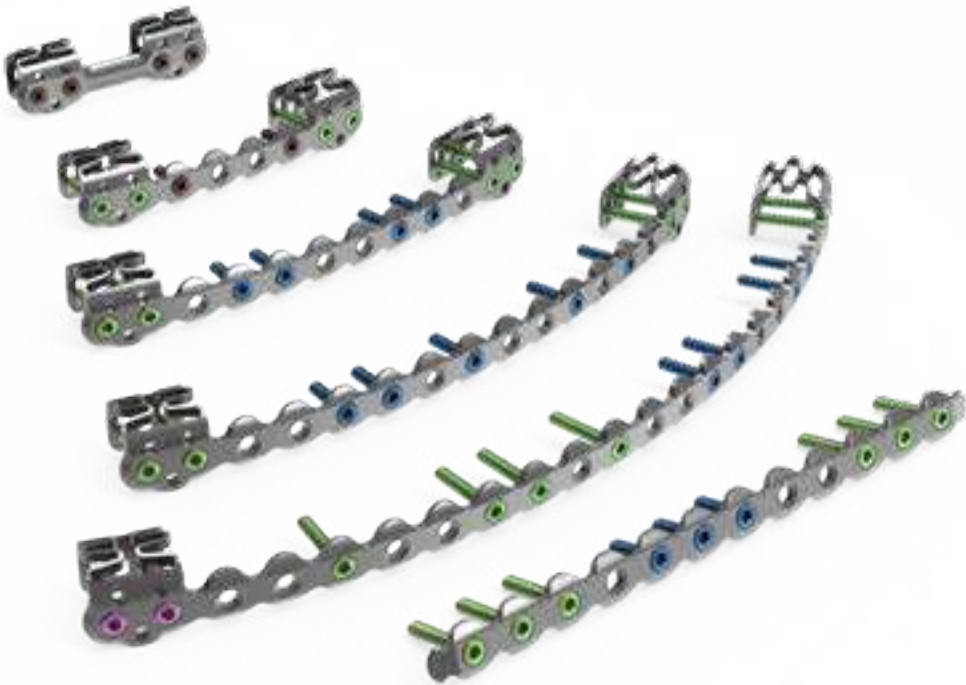

## Acumed® RibLoc® U Plus Chest Wall Plating System

The Acumed RibLoc U Plus Chest Wall Plating System is intended to stabilize and provide fixation for fractures, fusions, and osteotomies of the ribs, and for reconstructions of the chest wall and sternum. First to market with plates designed for the rib, this comprehensive system includes multiple plate options for varying fracture locations and patterns. Featuring patented U-plate technology, it is the only rib plating system that offers both U-plates and straight anterior plates. Color-coded screws and instrumentation are designed for accurate and efficient installation.

	Definition
<b>Warning</b>	Indicates critical information about a potential serious outcome to the patient or the user.
<b>Caution</b>	Indicates instructions that must be followed in order to ensure the proper use of the device.
<b>Note</b>	Indicates information requiring special attention.

# Table of Contents

System Features .....	<b>2</b>
Surgical Techniques .....	<b>6</b>
Preparing Handpieces .....	<b>6</b>
U Plus 90 Surgical Technique .....	<b>7</b>
Ordering Information .....	<b>17</b>

# System Features



Acumed was the first company to offer a plate specifically designed for rib fixation in 2006.

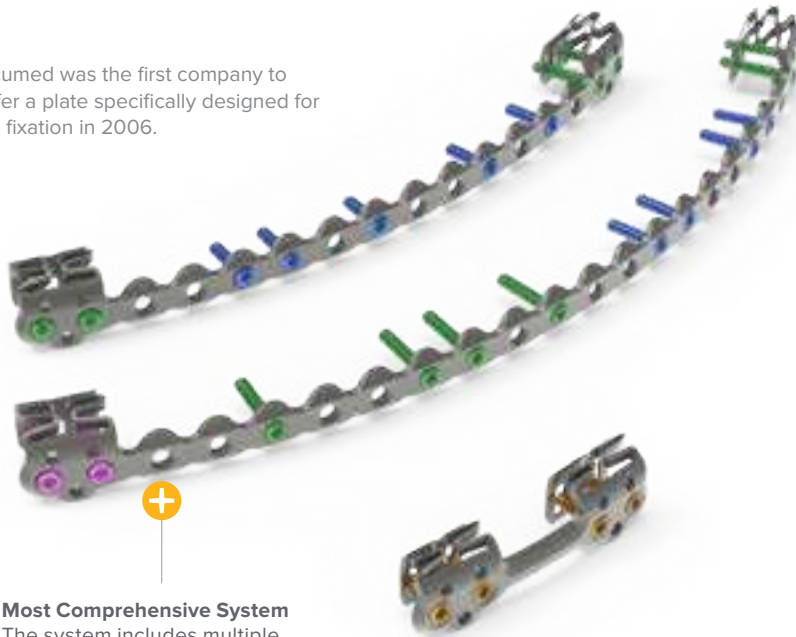

**Anterior and Posterior Locking**  
The U-clips are designed to minimize stress on the rib by distributing physiologic loads over a greater surface area. Once the screws are engaged and fixed to the cortices of the bone, the plate locks both anteriorly and posteriorly.

**Most Comprehensive System**  
The system includes multiple plate options for varying fracture locations and patterns.

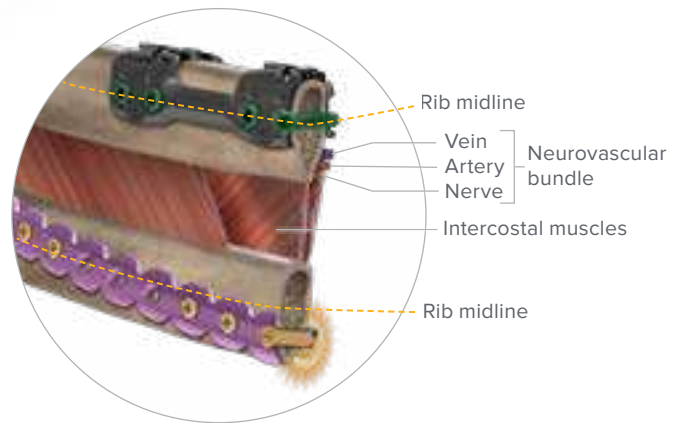

**Custom-fit**

The RibLoc® U Plus plate was designed to be customizable to the individual patient. The plates range in length from 50–215 mm, which allows the surgeon to address a broad range of fracture patterns. The advanced design of the plate offers a compressible U-clip for a perfect fit to a broad range of rib thicknesses (6–14 mm).

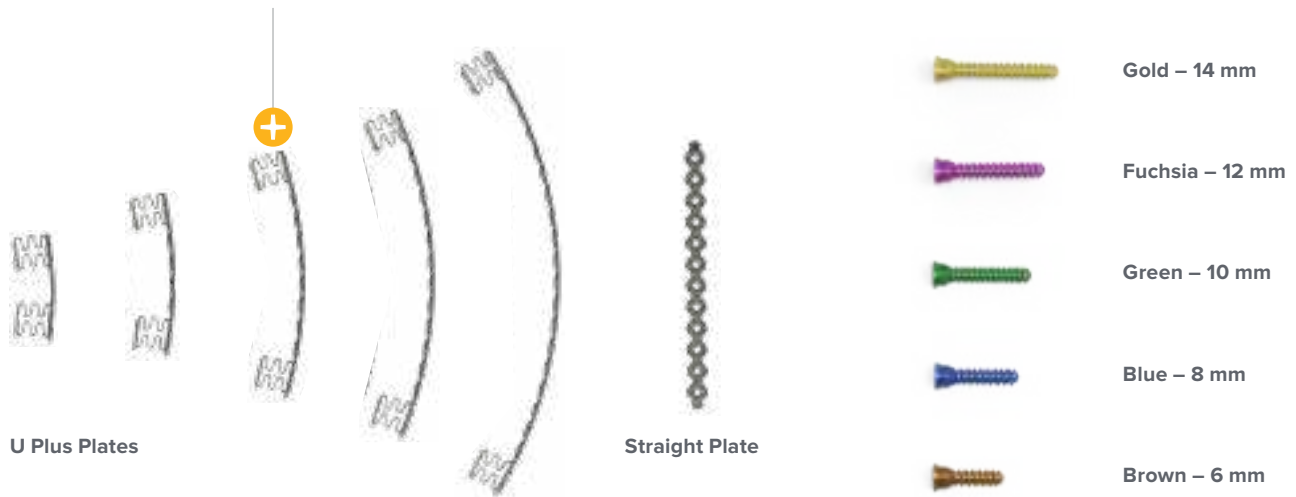

RibLoc U Plus 90 instrumentation is intended for use in conjunction with the RibLoc U Plus Chest Wall Plating System implants and instruments.



## System Features [continued]

### Low-Profile Guides

- ▶ Compress the U-clip to match rib thickness
- ▶ Clamp implant in place and maintain fracture reduction while drilling and installing screws
- ▶ Indicate correct screw size



RibLoc Low Profile Guide Assembly (RBL2520)

Color-coded 2.0 Drills (RBL231X)



T8 Power Driver Bit, Low-Profile (MSP2014)

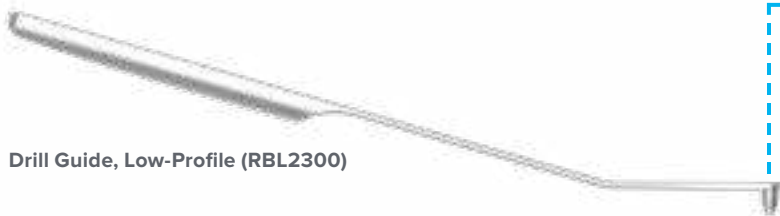

Drill Guide, Low-Profile (RBL2300)

Color-coded Drill Guides (RBL234X)  
Allow for one-handed guided drilling



Handle Extension (MSP2045)



T8 Forward Ratchet Assembly, Low-Profile (MSP2030)



T8 Reverse Ratchet Assembly, Low-Profile (MSP2035)



T8 Wrench Assembly, Low-Profile (MSP2040)

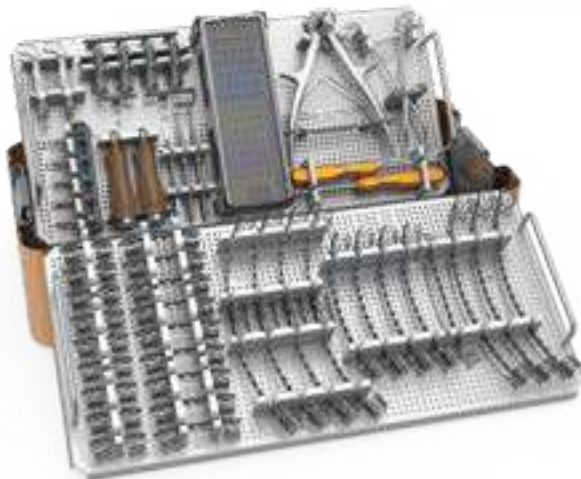

### RibLoc U Plus Chest Wall Plating System

RibLoc U Plus 90 instrumentation is intended for use in conjunction with the RibLoc U Plus Chest Wall Plating System implants and instruments.

## System Features [continued]

### W&H Implantmed Control Unit

Preset speed and torque settings for:

- ▶ Compressing the U-clips
- ▶ Drilling
- ▶ Driving screws



Implantmed SI-915 Control Unit (16929001)

#### W&H Implantmed Control Unit

Preset speed and torque settings for:

- ▶ Compressing the U-clips
- ▶ Drilling
- ▶ Driving screws



#### Back of Control Unit

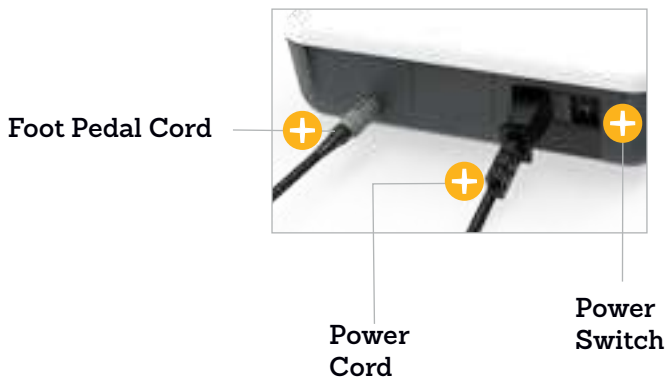

# System Features [continued]

## W&H Implantmed Control Unit Component



**WS-75 LG, Mini LED+ Surg  
Contra-Angle Handpiece 20:1  
(30032000)**

### Handpieces

- ▶ Contra-angle allows access while clearing the chest wall
- ▶ LED light for enhanced visibility when drilling
- ▶ Two handpieces allow for rapid switching between drilling and driving without changing out small bits



### Motor

**Motor With 3.5 m Cable  
(06631600)**



The W&H Implantmed motor, foot pedal, and handpiece should be set up according to the W&H Instructions For Use (IFU).

[https://www.wh.com/en\\_global](https://www.wh.com/en_global)

### Foot Pedal

**Mode**  
Cycle through  
Compress, Drill,  
and Screw modes



**Direction**  
Switch between  
Forward and Reverse

**Foot Control SN-1 (06202400)**

## Preparing Handpieces

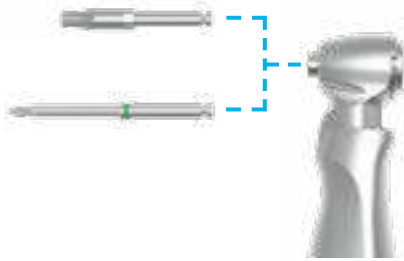

### 1 Attach the Drill or Driver

1. Insert the 10 mm x 2.0 Drill (RBL2313) or T8 Power Driver Bit, Low-Profile (MSP2014) until it stops.
2. Rotate the bit until it engages and clicks into place fully.
3. Check that the fit is secure by gently pulling on the bit.
4. To **remove**, push the button on the top of the head and release the bit.

**Tip:** Prepare WS-75 LG, Mini LED+ Surg Contra-Angle Handpiece 20:1 (30032000) with a T8 Power Driver Bit, Low-Profile and reserve the second handpiece for drilling. This allows for rapid switching between drilling and driving.

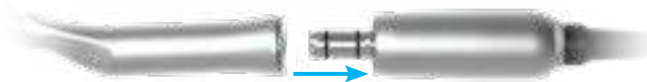

### 2 Attach the Handpiece to the Motor

1. Push the handpiece onto the motor With 3.5 m Cable (06631600) until it clicks into place.
2. Check that the handpiece is secure. There should be no gap between the handpiece and motor.
3. To **remove**, pull the handpiece from the motor.



### 3 Attach the Motor Extension Handle

If additional length to hold the motor is desired, attach the Handle Extension (MSP2045) by laying the motor cable in the slot and pushing the handle onto the motor until it clicks into place.



# U Plus 90 Surgical Technique

## 1 Select the Plate

1. After exposing the fracture, select the desired Rib Plate (RBL130X) length and prepare for placement.
2. Select a plate that allows at least 5 mm between the fracture and the nearest U-clip.

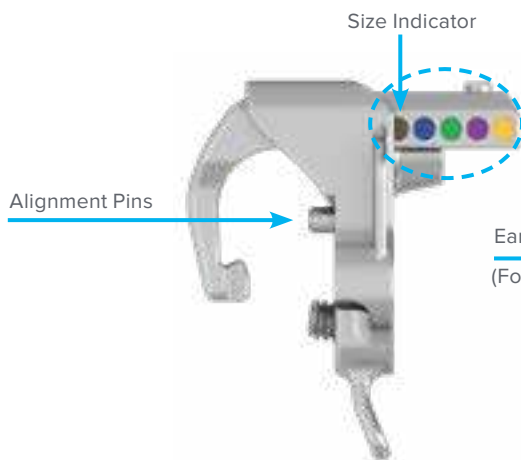

### Low Profile Guide Overview

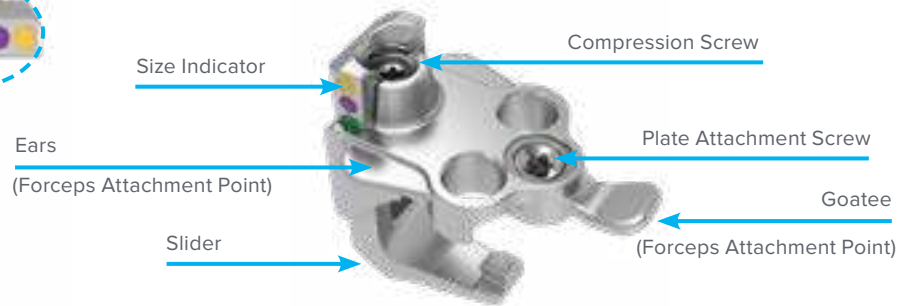

## 2 Attach the Low Profile Guides

1. Reset the RibLoc Low Profile Guide (RBL2520) by turning the Compression Screw counterclockwise, using the T8 Hexalobe Driver (MSP2013) from the U Plus tray, until it stops.
2. Align the Guide pins with the corresponding holes on the front of each U-clip.
3. Tighten the Attachment Screw with the T8 Hexalobe Driver.
4. Rotate the Compression Screw until the slider is engaged with the posterior rectangular slot of the U-clip.

**Attention:** Visually ensure the slider is engaged with the posterior rectangular slot of the U-clip. Adjust alignment by hand if necessary.

Do not start compressing the U-clip at this point.

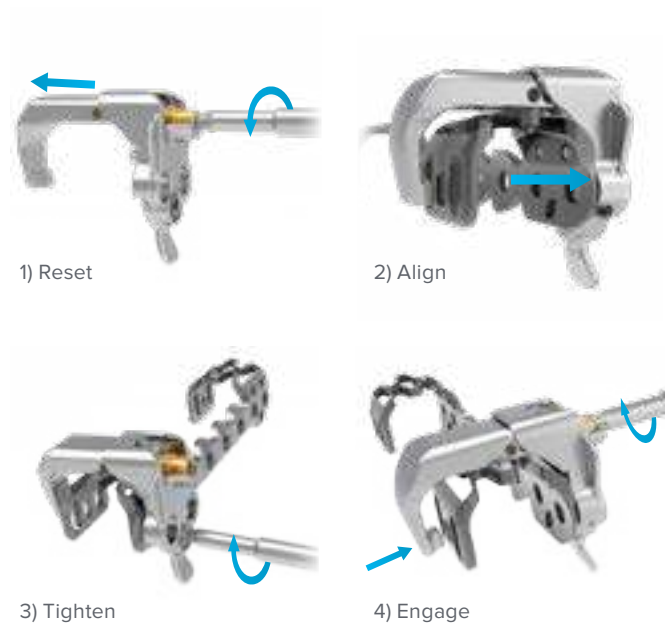

## U Plus 90 Surgical Technique [continued]

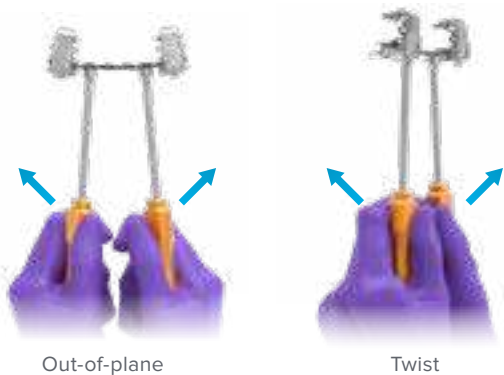
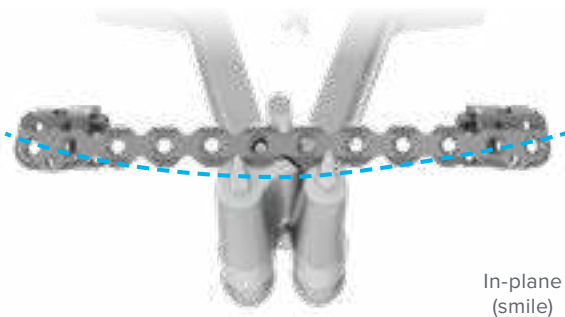
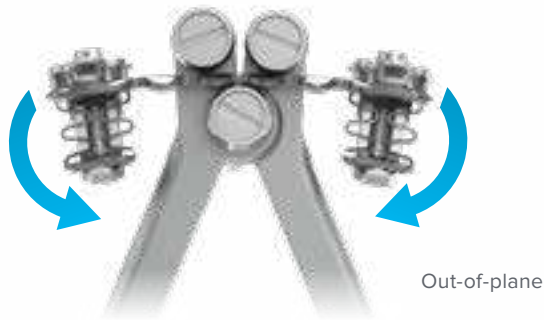

### 3 Contour the Plate

**If needed**, contour the plate to match the rib's geometry using the Bender Assembly (RBL2280) provided in the U Plus tray.

1. Hand Benders
  - ▶ For out-of-plane bending, place the plate between the rollers.
  - ▶ For in-plane bending, place the plate within the teardrop features.

**Note:** Contouring is typically needed for plates placed under the scapula.

**Note:** Contouring the plate with a bending template can be helpful when installing onto the rib.

**Note:** The RibLoc U Plus Bending Template (RBL2294) is not available in all markets.

**Tip:** Typical in-plane rib curvature is in the direction of a "smile" in higher ribs and a "frown" in lower ribs.

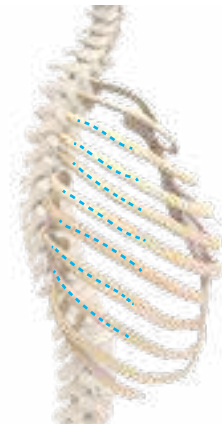

2. Bending Joystick Assembly (RBL2270)
  - ▶ Thread the two benders into the plate holes on either side of the desired contour location.
  - ▶ Use the handles to bend, twist, or straighten the plate.

**Caution:** Repetitive bending of the plate at the same location may weaken it.

## U Plus 90 Surgical Technique [continued]

### 4 Introduce the Plate

1. At each U-clip location, make a small incision immediately superior to the rib margin.

**Tip:** A curved periosteal elevator or curved forceps can be useful for intercostal dissection.

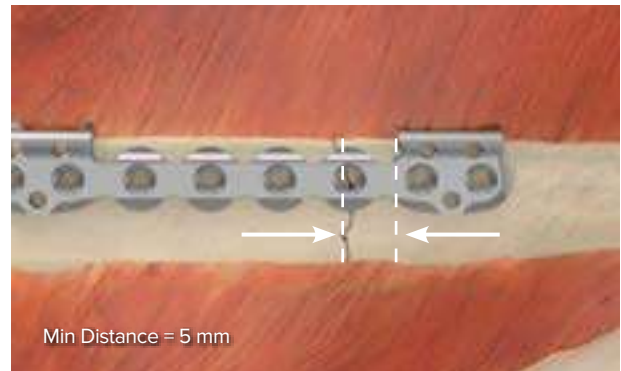

2. Place the Rib Plate (RBL130X) onto the rib at the desired location, using forceps to grasp the RibLoc Low Profile Guide (RBL2520) at attachment points (ears or goatee).
3. Use visualization and palpation to assess the contour and tracking of the plate. Reposition and recontour the plate, according to **Step 3**, as necessary.

**Tip:** Using straight or curved forceps can be helpful during plate placement.



## U Plus 90 Surgical Technique [continued]



Ensure that the Implantmed Motor With 3.5 m Cable (06631600), Foot Control SN-1 (06202400), and WS-75 LG, Mini LED+ Surg Contra-Angle Handpiece 20:1 (30032000) are set up according to the W&H Instructions For Use (IFU).



### 5 Prepare Control Unit to Compress U-clip

Prepare Implantmed SI-915 Control Unit (16929001) for U-clip compression.

1. Attach WS-75 LG, Mini LED+ Surg Contra-Angle Handpiece 20:1 (30032000) with the installed T8 Power Driver Bit, Low-Profile (MSP2014) to the Implantmed Motor With 3.5 m Cable (06631600).
2. Put the Control Unit in Compress mode by stepping on the orange pedal until Compress mode is selected.
3. Ensure the control unit is set to a torque of 30 Ncm. If necessary, use the +/- buttons to adjust.

**Warning:** Hand tightening may break RibLoc Low Profile Guide (RBL2520).

**Caution:** Over-compressing the U-clip may damage the bone or Guide.



### 6 Compress One U-clip to the Rib

1. Drive the Compression Screw, compressing the U-clip to match the thickness of the rib, until the control unit stops and beeps once.
2. Assess the compression of the U-clip by moving the U-clip relative to the bone. Little to no motion should be present.

**Warning:** Compressing the U-clip in a mode other than Compress mode may damage the bone or break the WS-75 LG, Mini LED+ Surg Contra-Angle Handpiece 20:1 (30032000) and RibLoc Low Profile Guide (RBL2520).

## U Plus 90 Surgical Technique [continued]

### 7 Approximate the Fracture and Compress Second U-clip

1. With one U-clip compressed, manipulate the rib to reduce the fracture.
2. Compress the second U-clip to maintain reduction for drilling and screw placement.

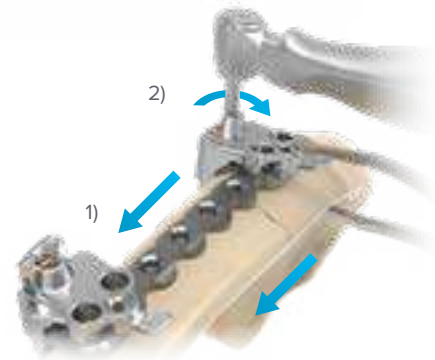

### 8 Prepare the Drill and Drill Guide

1. Read the size indicator on the RibLoc Low Profile Guide (RBL2520) by identifying the lowest color marking visible above the top surface of the guide.
2. Insert the corresponding color-coded 2.0 Drill (RBL231X) into the WS-75 LG, Mini LED+ Surg Contra-Angle Handpiece 20:1 (30032000) and install the handpiece onto the Implantmed Motor with 3.5 m Cable (06631600).
3. Install the corresponding color-coded Drill Guide Assembly (RBL234X) onto the head of the Handpiece by inserting the tip of the Drill into the nose of the Drill Guide Assembly from the side and clicking the head into place.
4. Push the Drill all the way through the Drill Guide Assembly.
5. Reset the Drill Guide Assembly by clicking it into place at the top of the Handpiece head. The Drill tip should be fully covered.

1) Select Drill Length

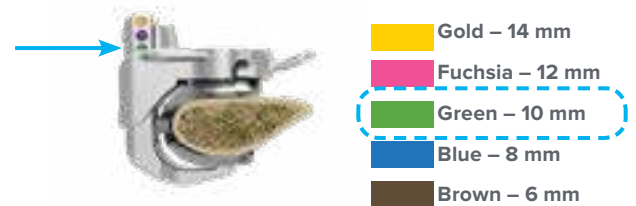

**Caution:** The Drill tip is sharp. Use caution when loading and unloading the Drill Guide Assembly.

**Note:** If desired, the Handheld Drill Guide, Low-Profile (RBL2300) may be used with any size drill in lieu of the color-coded Drill Guides.



**Note:** To remove the Drill Guide Assembly, push down on the rim with thumb.

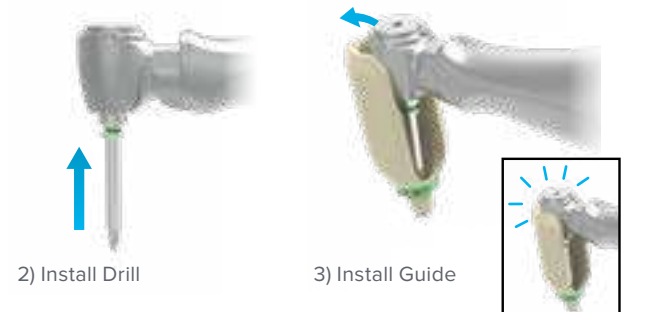

2) Install Drill

3) Install Guide



4) Push Drill Through

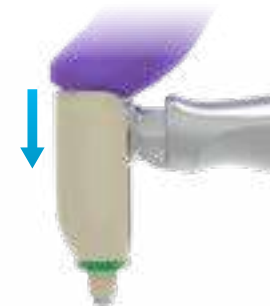

5) Reset Guide

Color	Drill Bit	Drill Guide
Brown	6 mm x 2.0 Drill (RBL2311)	6 mm Drill Guide Assembly (RBL2341)
Blue	8 mm x 2.0 Drill (RBL2312)	8 mm Drill Guide Assembly (RBL2342)
Green	10 mm x 2.0 Drill (RBL2313)	10 mm Drill Guide Assembly (RBL2343)
Fuchsia	12 mm x 2.0 Drill (RBL2314)	12 mm Drill Guide Assembly (RBL2344)
Gold	14 mm x 2.0 Drill (RBL2315)	14 mm Drill Guide Assembly (RBL2345)



## U Plus 90 Surgical Technique [continued]



### 9 Prepare Control Unit to Drill

1. Put the Implantmed SI-915 Control Unit (16929001) in Drill mode by stepping on the orange pedal until Drill mode is selected.
2. Ensure the control unit is set to 1000 rpm. If necessary, use the +/- buttons to adjust.

### 10 Drill Primary Holes

Use the Drill Guide Assembly (RBL234X) to drill primary holes.

1. Fully insert the nose of the Drill Guide Assembly into the barrel of the RibLoc Low Profile Guide (RBL2520).
2. Advance the drill until it bottoms out on the guide.
3. Repeat until all primary holes have been drilled.

**Note:** The color-coded Drill Guide Assembly must be reset before drilling each subsequent hole by clicking it into place at the top of the Handpiece head, fully covering the drill tip.

**Note:** Rib sizing may be different at each U-clip location. Check that the drill length matches the Primary Guide size indicator before drilling.

If desired, the handheld Drill Guide, Low-Profile (RBL2300) may be used instead of the color-coded Drill Guides.

## U Plus 90 Surgical Technique [continued]

### 11 Prepare Control Unit to Drive Screws

Prepare Implantmed SI-915 Control Unit (16929001) for screw installation.

1. Switch handpieces so that the T8 Power Driver Bit, Low-Profile (MSP2014) is installed.
2. Put the control unit in Screw mode by stepping on the orange pedal on the Foot Control SN-1 (06202400) until Screw mode is selected.
3. Ensure the Control Unit is set to 150 rpm. If necessary, use the +/- buttons to adjust.

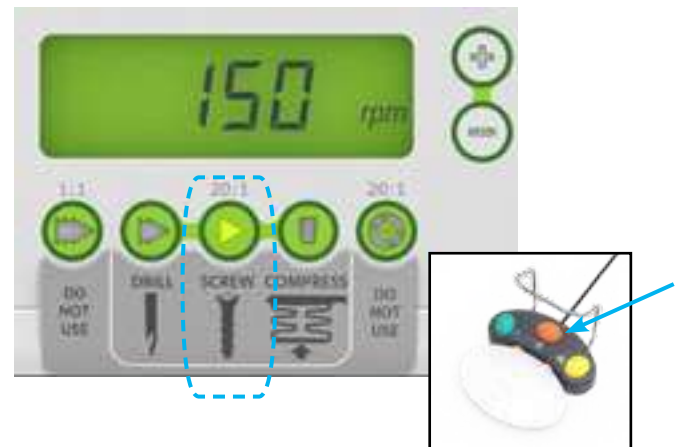

**Caution:** The handpiece can be damaged if a screw is installed while in Drill mode.

### 12 Select Screw

Select appropriate 2.7 mm Locking Screw (RBL122X).

1. Use the driver to retrieve the screw length indicated by the RibLoc Low Profile Guide (RBL2520).



Color	Screw
<b>Brown</b>	6 mm x 2.7 mm Locking Screw (RBL1221)
<b>Blue</b>	8 mm x 2.7 mm Locking Screw (RBL1222)
<b>Green</b>	10 mm x 2.7 mm Locking Screw (RBL1223)
<b>Fuchsia</b>	12 mm x 2.7 mm Locking Screw (RBL1224)
<b>Gold</b>	14 mm x 2.7 mm Locking Screw (RBL1225)

## U Plus 90 Surgical Technique [continued]



### 13 Install Screws in Primary Locations

1. Place the screw through the barrel of the RibLoc Low Profile Guide (RBL2520) and advance until the unit stops. A seated screw may be visualized through the window in the Primary Guide.
2. The T8 Forward Ratchet Assembly, Low-Profile (MSP2030) only needs to be used when the screw is not seated all the way with the power driver.
3. Repeat until all screws have been placed in the U-clips.

**Note:** Implantmed SI-915 Control Unit (16929001) will NOT beep in Screw mode.

**Note:** When using the Ratchet, the user should only apply torque until the screw is fully seated. The rep and surgeon should be aware that the Ratchet has a long handle and can supply excess torque if not used properly.

**Tip:** Let the WS-75 LG, Mini LED+ Surg Contra-Angle Handpiece 20:1 (30032000) do the work. Significant force is not needed.

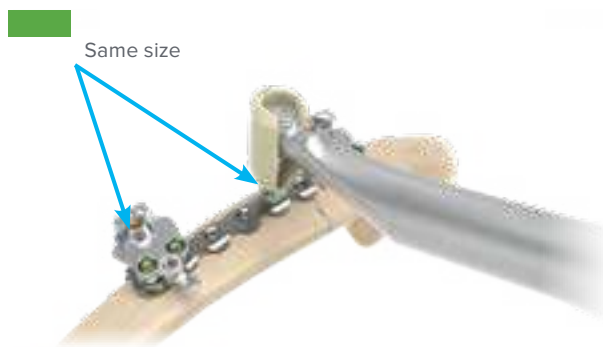

### 14 Drill Intermediate Holes

1. Prepare the Implantmed SI-915 Control Unit (16929001) to drill according to **Step 9**.
2. Use the same 2.0 mm Drill (RBL231X) length as that indicated by the nearest RibLoc Low Profile Guide (RBL2520) for the intermediate holes.
3. Introduce the nose of the Drill Guide Assembly (RBL234X) or handheld Drill Guide, Low-Profile (RBL2300) directly into the threaded plate hole.
4. Drill until the drill bottoms out on the Guide.

**Note:** Feel for the drill penetrating both cortices to ensure the correct drill depth has been reached.

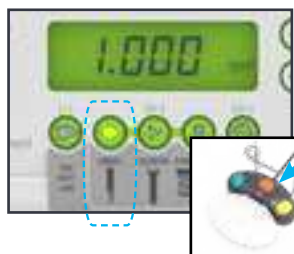

**Attention:** Check your Control Unit to ensure it is in the correct mode before your next step.

## U Plus 90 Surgical Technique [continued]

### 15 Place Intermediate Screws

1. Prepare the Implantmed SI-915 Control Unit (16929001) to place screws according to **Step 11**.
2. Check the color marking on the nearest RibLoc Low Profile Guide (RBL2520) and select a screw length that allows bicortical purchase. This is typically one size down, unless the rib is thicker than at the Guide location.
3. The T8 Forward Ratchet Assy, Low-Profile (MSP2030) only needs to be used when the screw does not seat all the way with the power driver.

**Note:** When using the T8 Forward Ratchet Assembly, Low-Profile, the user should only apply torque until the screw is fully seated. The rep and surgeon should be aware that the Ratchet has a long handle and can supply excess torque if not used properly.

**Note:** Insert screw minimum 5 mm from fracture location.

**Note:** If there is access, manually palpate the posterior rib surface for the screw tip to determine if there is bicortical purchase. If there is not, replace with a longer screw.

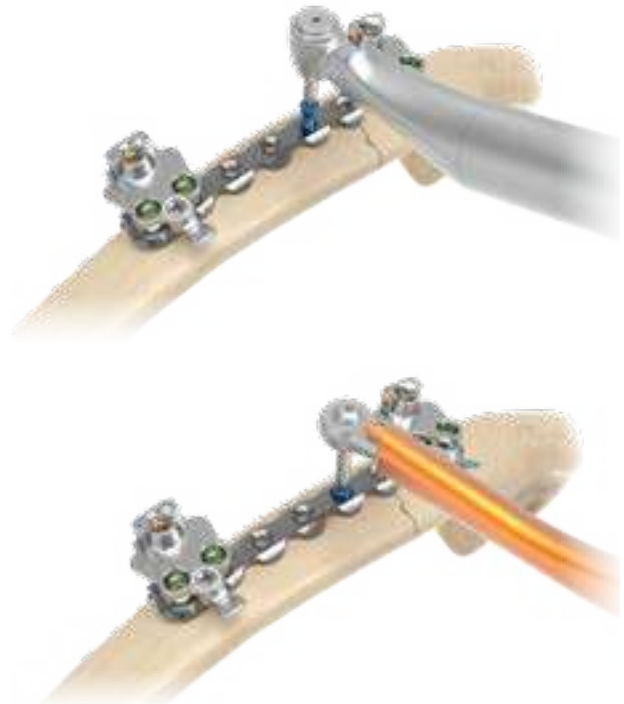

### 16 Remove the Low Profile Guides

1. Put the Implantmed SI-915 Control Unit (16929001) into Compress mode by pressing the orange pedal.
2. Set the Control Unit to reverse by pressing the yellow pedal. The Compress mode light on the Control Unit will flash repeatedly when in reverse.

**Note:** Control Unit will beep three times before the system begins to drive in reverse.

3. Using the T8 Power Driver Bit, Low-Profile (MSP2014), release the RibLoc Low Profile Guide (RBL2520) Compression Screw and Attachment Screw.
4. Use forceps to remove the Primary Guides.

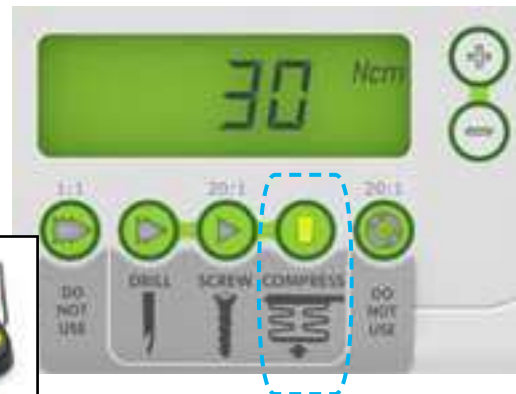

**Caution:** Reversing in a mode other than Compress mode may damage the Primary Guide or WS-75 LG, Mini LED+ Surg Contra-Angle Handpiece 20:1 (30032000).



## U Plus 90 Surgical Technique [continued]

### Implant Removal

For implant removal, screws may be removed with the T8 Reverse Ratchet Assembly, Low-Profile (MSP2035) and Control Unit.

### Additional System Information

If desired, one of the U-clips may be cut off using standard OR plate cutters. Use a minimum of three screws to secure the plate at the cut-end.

### Straight Plate (RBL1401) Information

If using the 126 mm Straight Plate (RBL1401) for the ribs or sternum fixation, please use the Sternum Fracture Technique RBL7029.



## Ordering Information

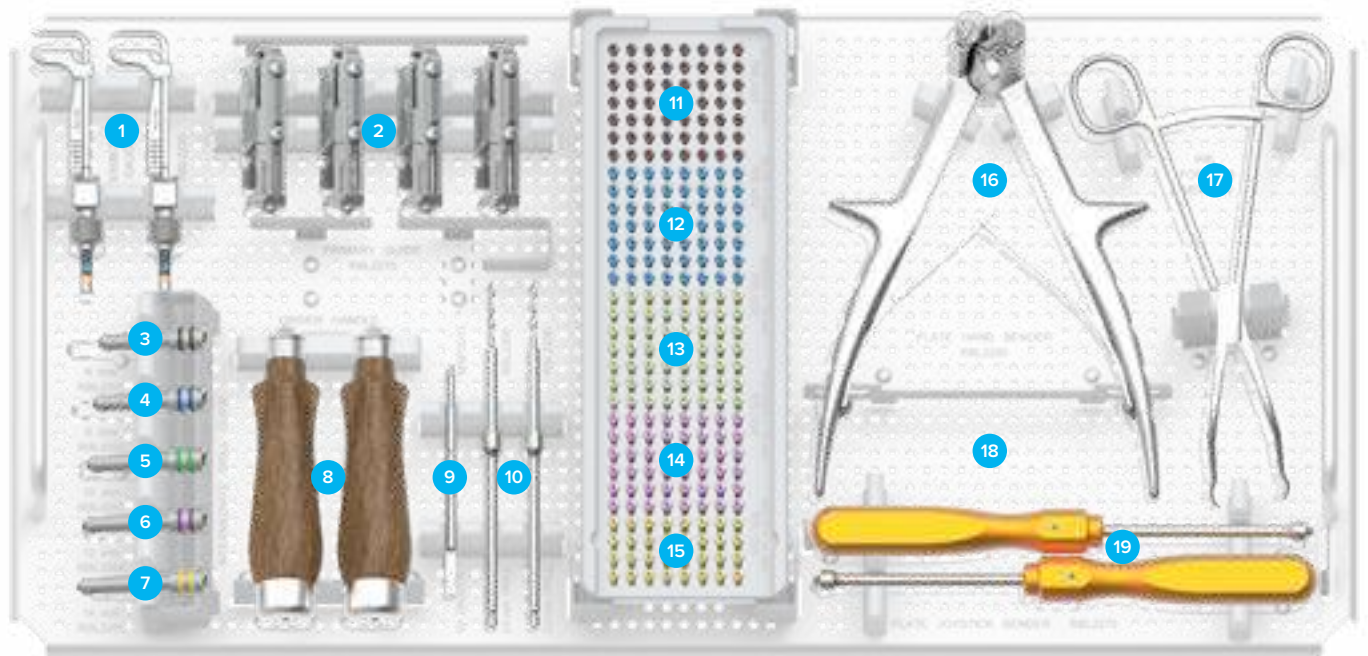

### Tray Components

#### Instruments

1	Intermediate Gauge Assembly	RBL2230	11	6 mm x 2.7 mm Locking Screw	RBL1221
2	Primary Guide Assembly	RBL2210	12	8 mm x 2.7 mm Locking Screw	RBL1222
3	6 mm Intermediate Guide	RBL2201	13	10 mm x 2.7 mm Locking Screw	RBL1223
4	8 mm Intermediate Guide	RBL2202	14	12 mm x 2.7 mm Locking Screw	RBL1224
5	10 mm Intermediate Guide	RBL2203	15	14 mm x 2.7 mm Locking Screw	RBL1225
6	12 mm Intermediate Guide	RBL2204	16	Bender Assembly	RBL2280
7	14 mm Intermediate Guide	RBL2205	17	Rib Forceps	MSP2020
8	Quick Release Driver	MSP2000	18	RibLoc U+ Chest Wall Plating System	RBL4020
9	T8 Hexalobe Driver	MSP2013	19	Bending Joystick Assembly	RBL2270
10	2.0 mm Drill	RBL2206			

## Ordering Information

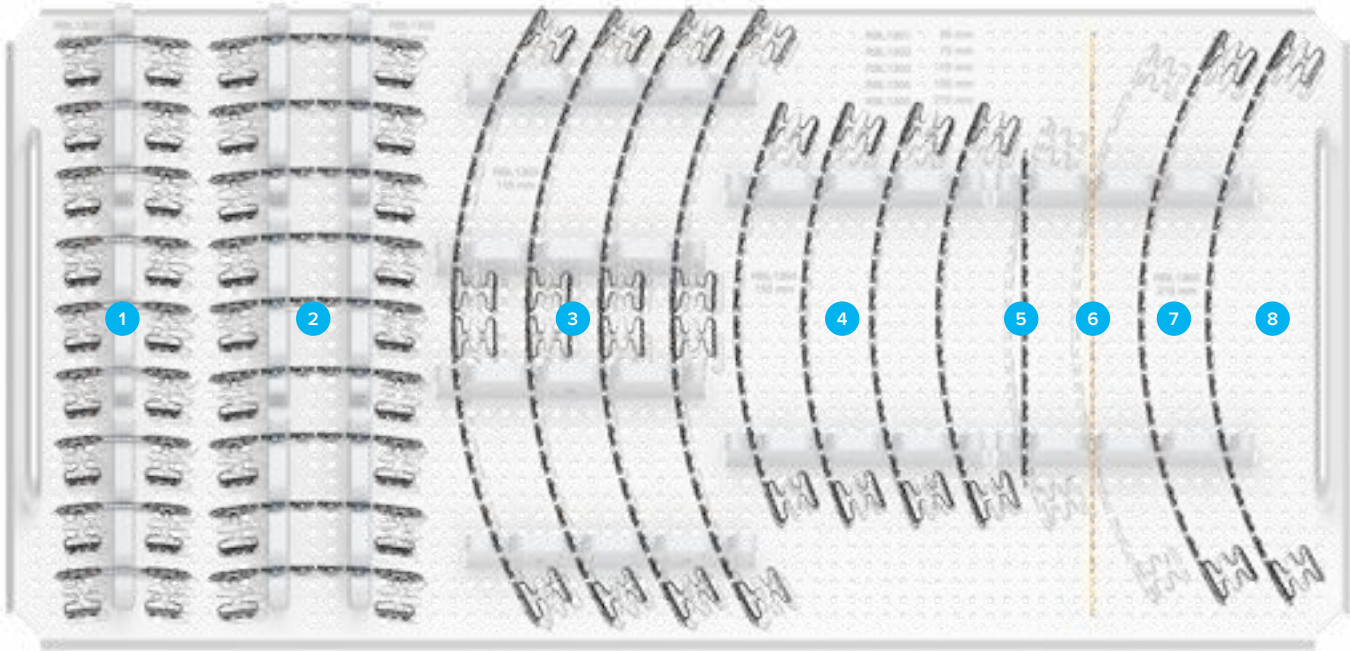

### Tray Components

#### Implants

1	50 mm Rib Plate	RBL1301	5	126 mm Straight Plate	RBL1401
2	75 mm Rib Plate	RBL1302	6	RibLoc U Plus Bending Template	RBL2294
3	115 mm Rib Plate	RBL1303	7	215 mm Rib Plate	RBL1305
4	155 mm Rib Plate	RBL1304	8	RibLoc U+ Chest Wall Plating System	RBL4020

**Note:** To learn more about the full line of Acumed innovative surgical solutions, please contact your authorized Acumed distributor, call 888.627.9957, or visit [www.acumed.net](http://www.acumed.net).

## Ordering Information

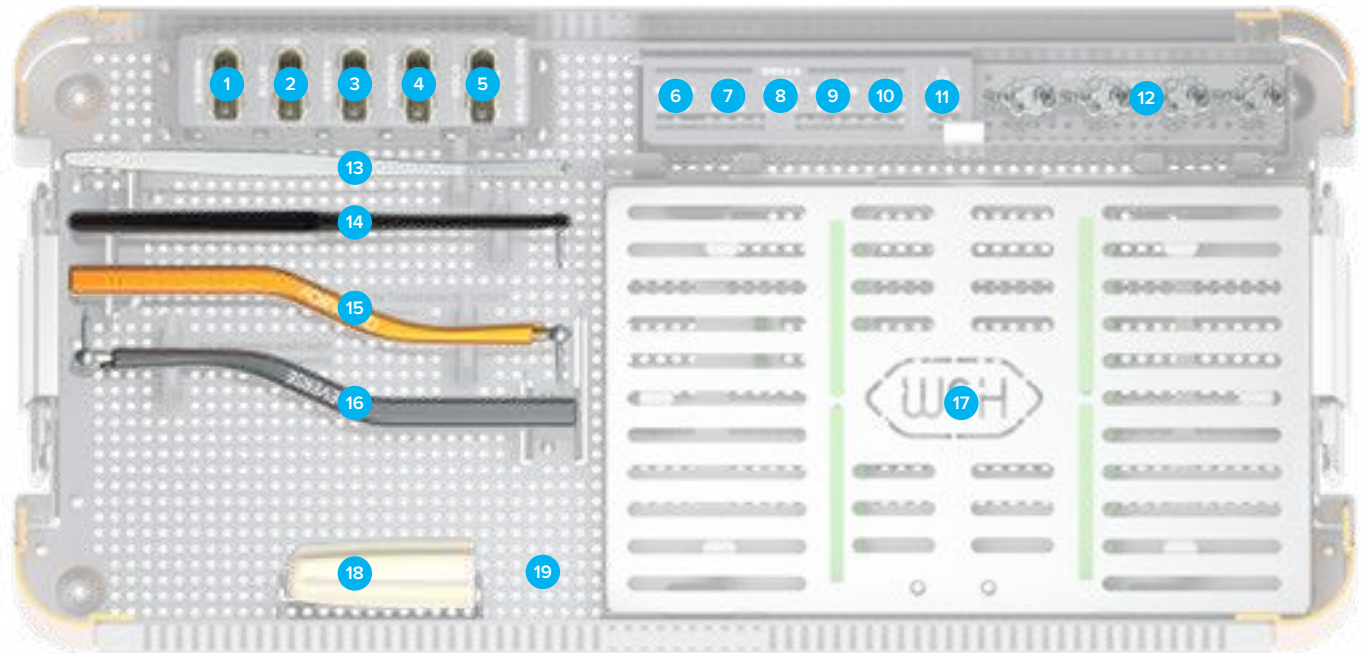

### Tray Components

#### RibLoc U Plus 90 Instrumentation Set

1	6 mm Drill Guide Assembly	RBL2341	11	T8 Power Driver Bit, Low-Profile	MSP2014
2	8 mm Drill Guide Assembly	RBL2342	12	RibLoc Low Profile Guide	RBL2520
3	10 mm Drill Guide Assembly	RBL2343	13	Drill Guide, Low-Profile	RBL2300
4	12 mm Drill Guide Assembly	RBL2344	14	T8 Wrench Assy, Low-Profile	MSP2040
5	14 mm Drill Guide Assembly	RBL2345	15	T8 Forward Ratchet Assy, Low-Profile	MSP2030
6	6 mm x 2.0 mm Drill	RBL2311	16	T8 Reverse Ratchet Assy, Low-Profile	MSP2035
7	8 mm x 2.0 mm Drill	RBL2312	17	Sterilization Cassette	04013500
8	10 mm x 2.0 mm Drill	RBL2313	18	Handle Extension	MSP2045
9	12 mm x 2.0 mm Drill	RBL2314	19	RibLoc U Plus Low-Profile Instrument Tray	RBL4030
10	14 mm x 2.0 mm Drill	RBL2315			

# Ordering Information



Only available in US

## W&H Power Control - Implantmed (US Only)

### Implantmed

1	Implantmed SI-915 Control Unit	16929001	4	Foot Control SN-1	06202400
2	Motor With 3.5 m Cable	06631600	5	Handle For Foot Pedal	4653500
3	WS-75 LG, Mini LED+ Surg Contra-Angle Handpiece 20:1	30032000			

## Additional Components

### Implantmed

	Spray Cap With Nozzle	02038200
	Power Cord HG – US/Canada	02821400
	W&H Service-Oil F1, MD-400	10940021

**Note:** To learn more about the full line of Acumed innovative surgical solutions, please contact your authorized Acumed distributor, call 888.627.9957, or visit [www.acumed.net](http://www.acumed.net).







[www.acumed.net](http://www.acumed.net)

Acumed USA Campus  
5885 NE Cornelius Pass Road  
Hillsboro, OR 97124  
+1.888.627.9957

OsteoMed USA Campus  
3885 Arapaho Road  
Addison, TX 75001  
+1.800.456.7779

Acumed Iberica Campus  
C. Proción, 1  
Edificio Oficor  
28023 Madrid, Spain  
+34.913.51.63.57

**RBL7017-N** | Effective: 2023/12 | © 2023 Acumed® LLC

These materials contain information about products that may or may not be available in any particular country or may be available under different trademarks in different countries. The products may be approved or cleared by governmental regulatory organizations for sale or use with different indications or restrictions in different countries. Products may not be approved for use in all countries. Nothing contained in these materials should be construed as a promotion or solicitation for any product or for the use of any product in a particular way that is not authorized under the laws and regulations of the country where the reader is located. Nothing in these materials should be construed as a representation or warranty as to the efficacy or quality of any product, nor the appropriateness of any product to treat any specific condition. Physicians may direct questions about the availability and use of the products described in these materials to their authorized Acumed distributor. Specific questions patients may have about the use of the products described in these materials or the appropriateness for their own conditions should be directed to their own physician.

Refer to the provided instructions for use for the complete indications, contraindications, warnings, and instructions for use.

Not all products may currently be available in all markets.

Please also refer to the package insert(s) or other labeling associated with the devices identified in this reference guide for additional information.

Acumed is a Distributor of W&H Impex

Acumed® and RibLoc® are registered trademarks of Acumed LLC.